

SpecSeal® Quick Clip™ Perimeter Fire Barrier System

The SpecSeal® Quick Clip™ Perimeter Fire Barrier System is designed to accelerate the installation of curtain wall insulation for perimeter fire barrier systems. The system's unique U-Brackets clip onto the mullions without direct attachment by screws to support the curtain wall insulation. Self-locking fasteners secure the insulation panels in place. Each U-Bracket has a receiving slot to lock an "L-shaped" stiffener channel in place without the need for mechanical attachment by screws.

Traditional methods for curtain wall insulation support often require light gauge metal to be cut and fabricated onsite and fastened into mullions with screws. The Quick Clip™ U-Brackets lock into place on the mullion with a strike from a mallet. The Quick Clip™ Z-Brackets attach to the mullion using screws for corner or non-standard applications.

The insulation fasteners are faster to install than screws or weld pins and lock in by hand. The U-Brackets are designed to provide easy location for the Quick Clip™ fasteners. Unlike traditional insulation hangers with impaling pins or spikes that face out, the Quick Clip™ fasteners push in, affording workers better safety.

Mullion insulation applied below the floor is secured in place with spiral screws.

SpecSeal® Quick Clip™ Perimeter Fire Barrier Systems are used in conjunction with UL Certified mineral wool and SpecSeal® brand coatings.

Specifications

Specified Divisions

Division 7	07 84 53	Building Perimeter Firestopping
Division 8	08 44 00	Curtain Wall and Glazed Assemblies

Performance

- Tested per ASTM E2307 for fire resistance
- Tested for wind cycling exposure in accordance with ASTM E1233
 - Loading Equivalent to 108 mph wind for 500 cycles

Features & Benefits

- Quick installation; fewer tools and no fasteners*
 - Easy installation of stiffener channel
 - Increased safety by reducing cutting sharp metal and impaling pins or spikes
 - Patent Nos. 10,329,761, 10,329,762, others pending
- *If mullion tolerances prevent snug fit of U-Brackets, a screw will be required to hold the bracket in place

System Selection

To find your firestop system or create a submittal, <https://systems.stifirestop.com/> to use System Search & Submittal Builder. You may also visit the UL Online Certifications Directory/UL Product iQ™ for complete listings. (Firestop Systems).

Technical Service

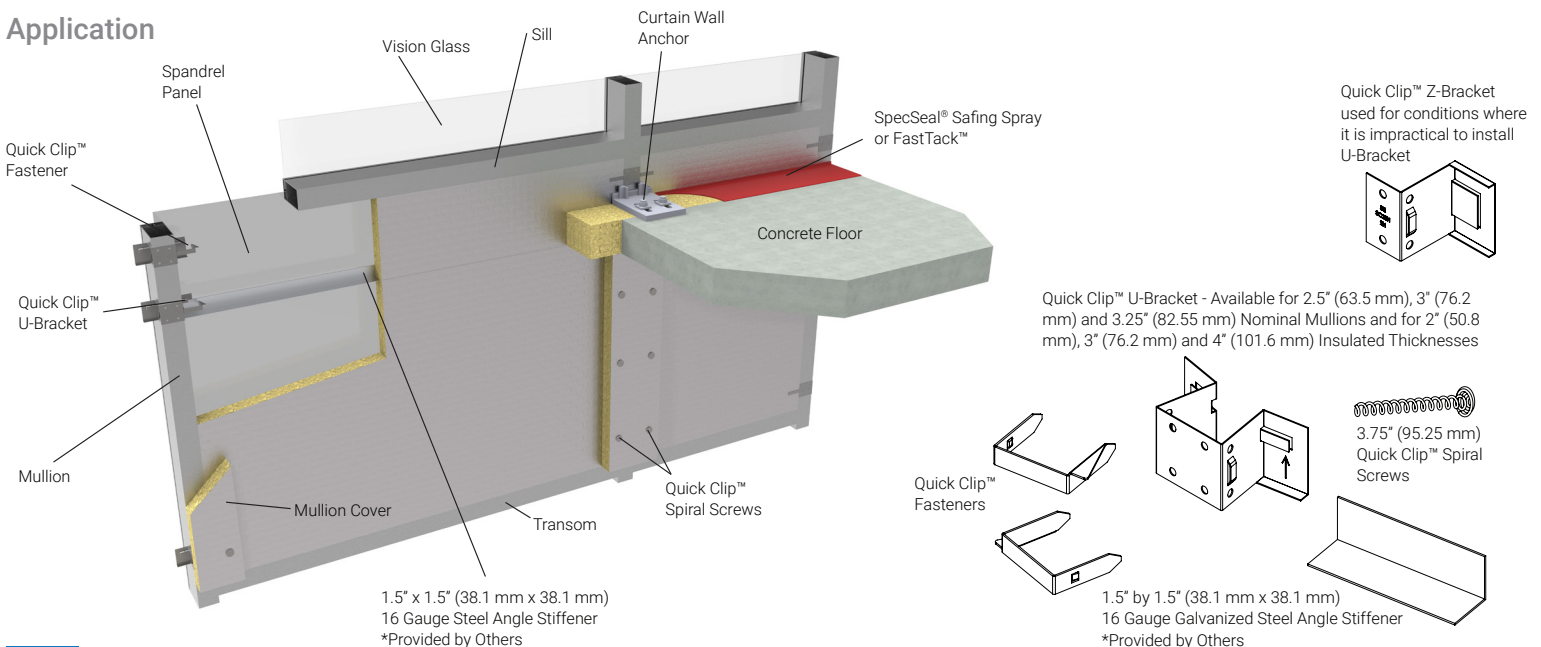

Specified Technologies Inc. provides toll free technical support to assist in product selection and appropriate installation design. UL System designs suitable for submittal or specification purposes are available on request. A complete library of technical information is provided at the company's website www.stifirestop.com including Safety Data Sheets (SDS's).

Application

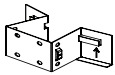
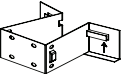
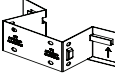
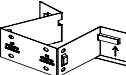
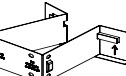
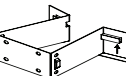
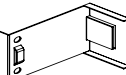
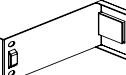

SpecSeal® Quick Clip™ Perimeter Fire Barrier System

ORDERING INFORMATION

Catalog Number	UPC Number	Description	Product Image	Mullion Width	Insulation	Weight (Each)	Case Qty.	Material
SC25020	730573100011	Quick Clip™ U-Bracket*			2" (50.8 mm)	0.31 lbs (0.14 kg)	100	
SC25030	730573100028	Quick Clip™ U-Bracket*		2.5" (63.5 mm)	3" (76.2 mm)	0.28 lbs (0.13 kg)	100	Heat treated galvanized steel
SC25040	730573100035	Quick Clip™ U-Bracket*			4" (101.6 mm)	0.32 lbs (0.15 kg)	100	
SC30020	730573100042	Quick Clip™ U-Bracket			2" (50.8 mm)	0.25 lbs (0.11 kg)	100	
SC30030	730573100059	Quick Clip™ U-Bracket		3" (82.6mm)	3" (76.2 mm)	0.30 lbs (0.14 kg)	100	Heat treated galvanized steel
SC30040	730573100066	Quick Clip™ U-Bracket			4" (101.6 mm)	0.35 lbs (0.16 kg)	100	
SC32520	730573100073	Quick Clip™ U-Bracket			2" (50.8 mm)	0.25 lbs (0.11 kg)	100	
SC32530	730573100028	Quick Clip™ U-Bracket		3.25" (82.6mm)	3" (76.2 mm)	0.30 lbs (0.14 kg)	100	Heat treated galvanized steel
SC32540	730573100097	Quick Clip™ U-Bracket			4" (101.6 mm)	0.34 lbs (0.15 kg)	100	
SC20H	730573100103	Quick Clip™ Z-Bracket			2" (50.8 mm)	0.13 lbs (0.06 kg)	100	
SC30H	730573100110	Quick Clip™ Z-Bracket		All	3" (76.2 mm)	0.15 lbs (0.07 kg)	100	Galvanized steel
SC40H	730573100127	Quick Clip™ Z-Bracket			4" (101.6 mm)	0.14 lbs (0.06 kg)	100	
SB2020	730573100257	Quick Clip™ Fastener		All	All	0.04 lbs (0.02 kg)	100	Galvanized steel
SA375	730573100264	Quick Clip™ Spiral Screw		All	All	0.02 lbs (0.01 kg)	1000	Galvanized steel

* For single extrusion mullions only

IMPORTANT NOTICE: ALL STATEMENTS, TECHNICAL INFORMATION, AND RECOMMENDATIONS CONTAINED HEREIN ARE BASED UPON TESTING BELIEVED TO BE RELIABLE, BUT THE ACCURACY AND COMPLETENESS THEREOF IS NOT GUARANTEED.

STI TYPICALLY WARRANTIES ITS PRODUCTS FOR ONE FULL YEAR. FOR COMPLETE DETAILS OF OUR STANDARD WARRANTY, PLEASE VISIT WWW.STIFIRESTOP.COM/LEGAL/WARRANTY

MADE IN THE USA - © 2019 SPECIFIED TECHNOLOGIES INC.

