

Maximum cable capacity. Cable loading area = 92 x 85 mm

Cable diameter (mm)	Cable capacity
Ø 3	868
Ø 3.5	648
Ø 4	483
Ø 5	323
Ø 5.5	255
Ø 6	210
Ø 6.5	182

Cable diameter (mm)	Cable capacity
Ø 7	156
Ø 8	110
Ø 9	90
Ø 10	72
Ø 11	56
Ø 12	49
Ø 13	42

Cable diameter (mm)	Cable capacity
Ø 14	36
Ø 15	30
Ø 16	25
Ø 17	25
Ø 18	20
Ø 19	20
Ø 20	16

Cable diameter (mm)	Cable capacity
Ø 21	16
Ø 22	12
Ø 25	9
Ø 30	6
Ø 35	4
Ø 50	2
Ø 80	1

The maximum cable capacity listed in this document may be affected by the cable diameter tolerance, cable roundness, cable position, cables combination and installation method.

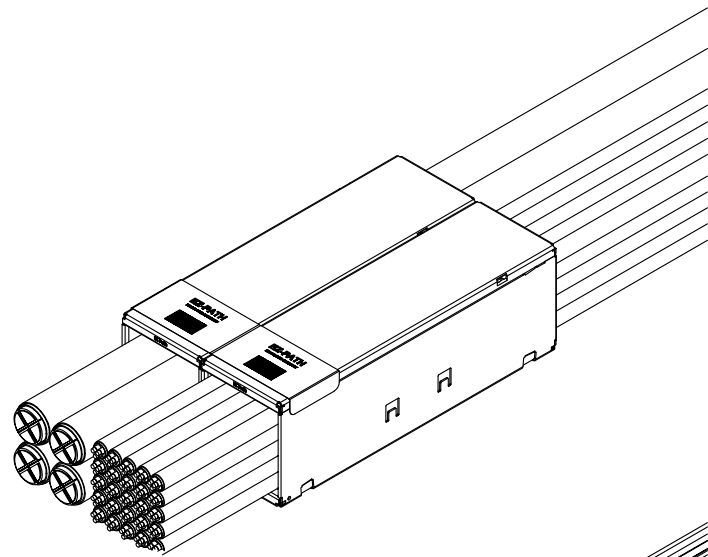
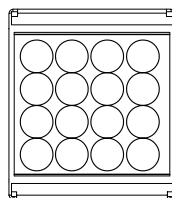
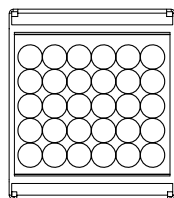
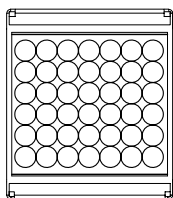
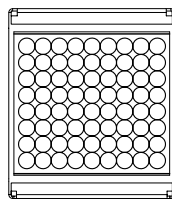
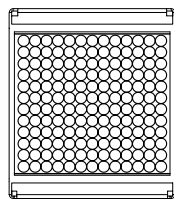
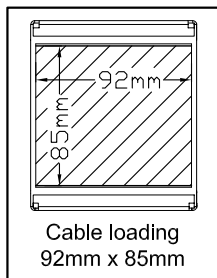

Some examples :

