

Maximum cable capacity. Cable loading area = 69 x 47 mm

Cable diameter (mm)	Cable capacity
Ø 3	368
Ø 3.5	266
Ø 4	204
Ø 5	130
Ø 5.5	108
Ø 6	88
Ø 6.5	70

Cable diameter (mm)	Cable capacity
Ø 7	63
Ø 8	48
Ø 9	35
Ø 10	28
Ø 11	24
Ø 12	20
Ø 13	15

Cable diameter (mm)	Cable capacity
Ø 14	12
Ø 15	12
Ø 16	9
Ø 17	8
Ø 18	6
Ø 19	6
Ø 20	6

Cable diameter (mm)	Cable capacity
Ø 21	6
Ø 22	6
Ø 25	4
Ø 30	2
Ø 35	2
Ø 50	1

The maximum cable capacity listed in this document may be affected by the cable diameter tolerance, cable roundness, cable position, cables combination and installation method.

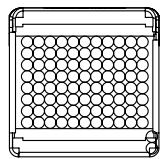
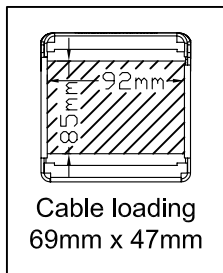

Ø 6mm  
Max 88 cables

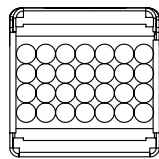

Ø 10mm  
Max 28 cables

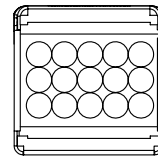

Ø 13mm  
Max 15 cables

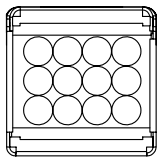

Ø 15mm  
Max 12 cables

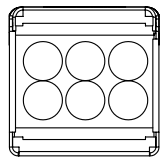

Ø 20mm  
Max 6 cables

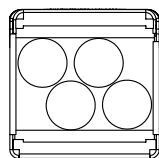

Ø 25mm  
Max 4 cables

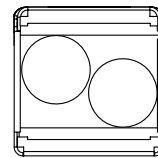

Ø 35mm  
Max 2 cables

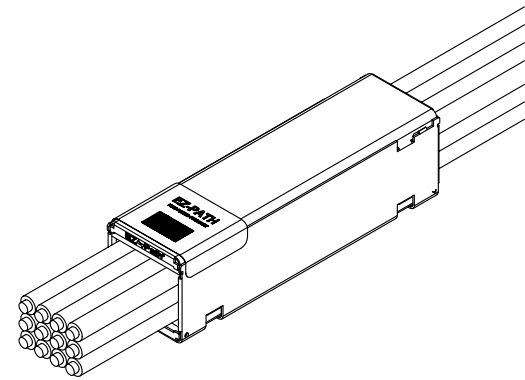

Some examples :

